

Jobs Desk – Rodolfo Dordoni – 2014



Jobs esprime in sé e nel suo nome l'atto conclusivo di un percorso progettuale innovativo. Il nuovo sistema d'arredo direzionale nasce da un'attenta riflessione sull'evoluzione dei comportamenti in relazione alle nuove tecnologie e da un'accurata selezione dei materiali: pelle, legni lucidi ed opachi e strutture in metallo spazzolato arricchiscono in tono sobrio ed essenziale i differenti volumi e determinano nuove aree di lavoro.

CARATTERISTICHE TECNICHE

Modelli.

- President Desk
- Executive Desk
- Easy Desk

Struttura portante. In acciaio satinato verniciato piombo con caratteristica sezione a "T". Piedini regolabili in materiale plastico.

Piano. Telaio portante interno in tubolare di acciaio verniciato nero opaco e pannellatura esterna in MDF.

Pannelli di tamponamento sottopiano. Verniciati nero testurizzato antigraffio.

"Guest area". Rappresenta la zona del piano di lavoro riservata all'ospite ed è disponibile in:

- Pelle, in abbinamento al piano
- Rovere opaco, in abbinamento alle altre parti in legno.

Rivestimento. In Pelle Frau®:

- Color System Frau® (SC)

Applicato a: piano, "Guest area" (se scelta in pelle), pannello di cortesia e frontale dei cassetti.

Finitura delle componenti in legno.

- Rovere tabacco
- Rovere piombo

Entrambe le finiture sono declinate in lucido o opaco in funzione delle parti interessate: mobile contenitore, cassetiera, colonna passacavi, "Guest area" (se scelta in legno), fascia centrale del piano, "Meeting area" e pannello di cortesia.

Fascia centrale piano. È realizzata in MDF impiallacciato in rovere con finitura opaca e corre per tutta la lunghezza del piano. Separa l'area di lavoro dalla "Guest area" e consente l'uscita dei cavi elettrici attraverso uno sportellino scorrevole che dà accesso a un vano interno al piano. Il vano, sempre posizionato in corrispondenza di colonna passacavi o mobile contenitore, è corredato di un vassoio portapenne completo di tappetino in pelle ed equipaggiato centralmente con un dispositivo di elettrificazione da acquistare separatamente.

Predisposizione passaggio cavi. Fornita e personalizzata in base ai dispositivi di elettrificazione scelti e specificati dal cliente in fase di acquisto. Tali dispositivi devono essere acquistati ed installati dal cliente successivamente alla consegna. Per assicurare una corretta predisposizione in fase produttiva si

Jobs expresses in itself and in its name the final act of an innovative design path. The new managerial system has been created through careful reflection on the evolution of behaviours in relationship to new technologies and through the careful selection of materials. Leather, polished and matte woods and brushed metal structures give a sober and essential feel to the different volumes and determine new working areas.

TECHNICAL FEATURES

Items.

- President Desk
- Executive Desk
- Easy Desk

Supporting structure. Made from brushed steel with a lead painted finish and a characteristic "T" section. Adjustable plastic feet.

Top. Internal supporting frame in tubular steel in a matte black finish and external panelling in MDF.

Under top infill panels. Painted black with a textured, scratch-resistant finish.

Guest area. It identifies the area of the work surface reserved for guests and is available in:

- Leather, in combination with the top
- Matte oak, in combination with the other wooden parts.

Covering. In Pelle Frau® leather:

- Color System Frau® (SC)

Applied to: top, Guest area (when in leather), modesty panel and drawer fronts.

Wooden components finishing.

- Tobacco oak
- Lead oak

Both can be in a polished or matte finishing depending on the components involved: cabinet unit, drawer cabinet, cable management column, Guest area (if chosen in wood), top central strip, Meeting area and modesty panel.

Top central strip. It runs the entire length of the top and separates the work surface from the Guest area. Made of MDF in a matte oak veneer, it allows the electrical cables to come out from a sliding slot which also gives access to an internal compartment on the desktop. The compartment, always placed in correspondence to the cable management column or the cabinet unit, also contains a pen tray covered with a leather mat and equipped with a central electrification device that is purchased separately.

Predisposition for the cable management system. It is supplied and personalised based on the electrical devices chosen and specified by the customer at the time the order is placed. These devices must be purchased and installed by the client following delivery. To ensure proper placement during the

raccomanda l'invio di un campione.

Optional.

- Senza accessori
- Con pannello di cortesia

Pannello di cortesia. In alluminio verniciato nero opaco e rivestito in pelle.

PRESIDENT DESK

Versioni.

- President Desk 72"
- President Desk Standard
- President Desk Large

Mobile contenitore. In MDF impiallacciato in rovere lucido. Top rifinito a contrasto con finitura opaca. Il mobile è attrezzato con due cassetti e un classificatore che nasconde al suo interno un ulteriore cassetto. La struttura interna di cassetti e classificatore è verniciata nero testurizzato antigraffio con frontali rivestiti in pelle. Serratura a chiave posizionata sul fianco del mobile per la chiusura dei soli due cassetti posizionati all'estremità della scrivania. Le versioni Standard e Large sono attrezzate nel lato opposto con un vano a giorno con ripiano in vetro e divisorio verticale in acciaio satinato verniciato color piombo.

Posizione mobile.

- Mobile a destra
- Mobile a sinistra

Passaggio cavi (eccetto President Desk 72"). Colonna passacavi in metallo verniciato nero semio opaco dotata di uno sportellino mediante il quale è possibile accedere ai cavi dal top del mobile. Su richiesta è possibile attrezzare la versione President Desk 72" con uno sportellino mediante il quale è possibile accedere ai cavi dal top del mobile. La colonna passacavi può essere montata a destra o a sinistra.

EXECUTIVE DESK, EASY DESK

Versioni.

- Executive Desk 72"
- Executive Desk Standard
- Executive Desk con "Meeting area"
- Executive Desk Large
- Easy Desk Standard
- Easy Desk con "Meeting area"
- Easy Desk Large

Passaggio cavi. Colonna passacavi in metallo verniciato nero semio opaco. Su richiesta è possibile attrezzare la colonna della versione Executive Desk 72" di uno sportellino mediante il quale è possibile accedere ai cavi dal top del mobile. La colonna passacavi può essere montata a destra o a sinistra.

Posizione colonna.

- Colonna a destra
- Colonna a sinistra

Cassettiera (eccetto Easy Desk ed Executive 72"). In MDF impiallacciato in rovere lucido. Top rifinito a contrasto con finitura opaca. È sospesa, posizionata sul lato opposto della colonna passacavi, e dotata di un solo cassetto a vista che ne nasconde un secondo accessibile solo dall'interno. La struttura interna è verniciata nero testurizzato antigraffio con frontali rivestiti in pelle. Una serratura a chiave, con impugnatura in pelle, è posizionata sul fianco destro della cassetta e un vano a giorno caratterizza il lato opposto al cassetto. Nella versione 72" la cassetta è in appoggio, dotata di zoccolo realizzato con pannelli in MDF e faggio, verniciato nero antigraffio e piedi regolabili in materiale plastico.

"Meeting area" (eccetto Executive Desk 72"). È di forma circolare e realizzato in multistrato di pioppo e pannelli in MDF impiallacciato in rovere opaco. Il piano "Meeting area" è fissato alle strutture metalliche della scrivania e della

production process, customers are strongly encouraged to submit a sample.

Accessories.

- Without accessories
- With modesty panel

Modesty panel. Made of matte black polished aluminium covered with leather.

PRESIDENT DESK

Versioni.

- President Desk 72"
- President Desk Standard
- President Desk Large

Cabinet unit. Made of MDF in a polished oak veneer. The top features a contrasting matte finish. The unit is equipped with 2 drawers and a file drawer which contains another hidden drawer. The internal structure is painted black with a textured scratch-resistant finish. The drawer fronts are covered with leather. A key lock positioned on the side of the cabinet allows you to lock the 2 drawers located at the end of the desk. Standard and Large versions have an open compartment on the opposite side, with a glass shelf and vertical dividing panel in lead-painted brushed steel.

Cabinet position.

- Right-hand cabinet
- Left-hand cabinet

Cable management (except President Desk 72"). Column in semi-matt black painted metal with a small door that gives access to the cables from the top of the unit. On request, for the President Desk 72", a small door for the cable management can be fitted to the column under the top. The cable management column can be fitted on the right or the left.

EXECUTIVE DESK, EASY DESK

Versioni.

- Executive Desk 72"
- Executive Desk Standard
- Executive Desk with "Meeting area"
- Executive Desk Large
- Easy Desk Standard
- Easy Desk with "Meeting area"
- Easy Desk Large

Cable management. Column in semi-matt black painted metal. On request, for the Executive Desk 72", a small door for the cable management can be fitted to the column under the top. The cable management column can be fitted on the right or the left.

Column position.

- Right-hand column
- Left-hand column

Drawer cabinet (except for Easy Desk and Executive 72"). Made of MDF in a polished oak veneer. The top features a contrasting matte finish. The cabinet is suspended and positioned on the opposite side of the cable management column. It is equipped with one drawer which conceals another one accessible only from the inside. The internal structure is painted black with a textured scratch-resistant finish. The drawer fronts are covered with leather. A key lock with a leather grip is positioned on the right side of the drawer cabinet. The opposite side of the drawer is furnished with an open compartment. In the 72" version, the drawer cabinet rests on top, on a base made from MDF and beech panels, painted in scratch-resistant black, with adjustable plastic feet.

"Meeting area" (except for Executive Desk 72"). Circular surface made of poplar plywood and MDF panels in a matte oak veneer. The Meeting area surface is attached to the metal structure of the desk and the cable

colonna passacavi tramite piastre di acciaio verniciate nero opaco. Questo può essere installato esclusivamente sul lato dove è presente la colonna passacavi.

management column using matte black steel plates. This top can only be installed on the same side as the cable management column.

SPECIFICHE TECNICHE / TECHNICAL SPECIFICATIONS

PASSAGGIO CAVI / CABLE MANAGEMENT SYSTEM

JOBS PRESIDENT DESK

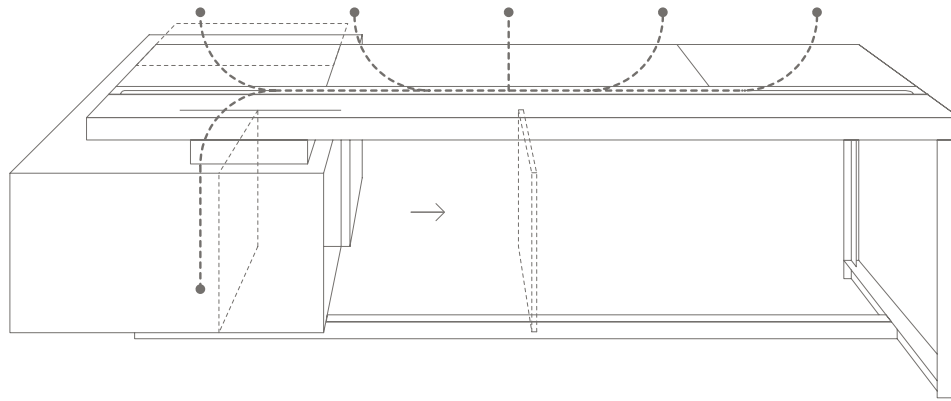

JOBS EXECUTIVE DESK

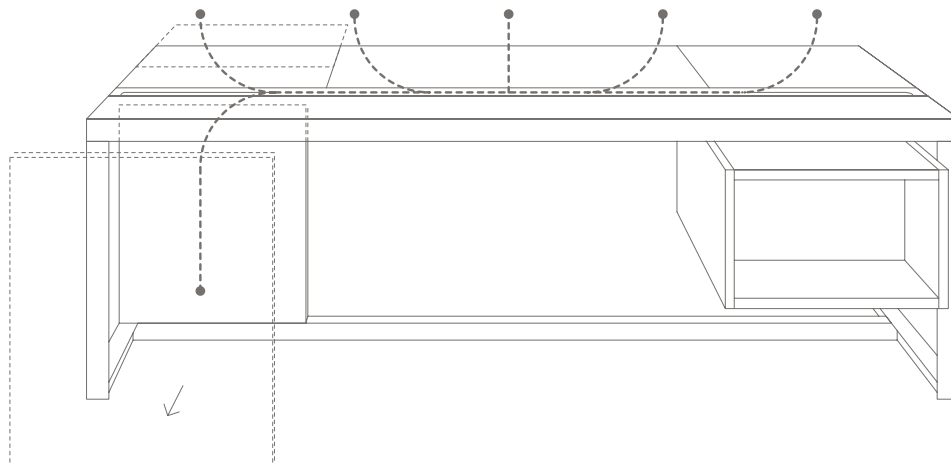

5580698

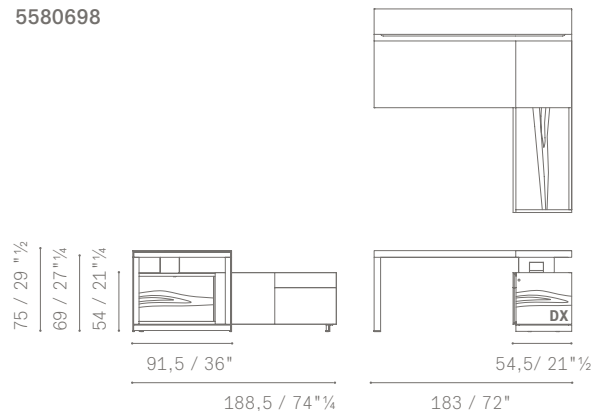

5580698

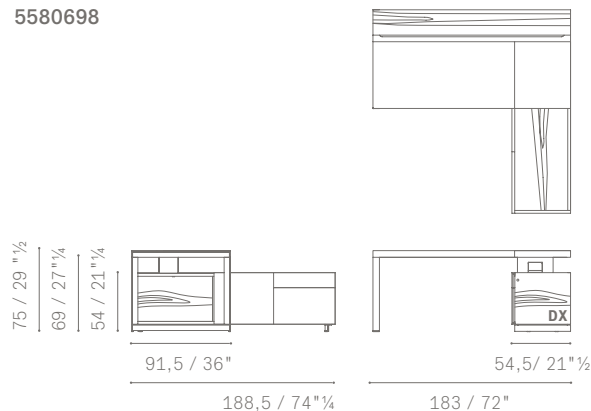

5580706

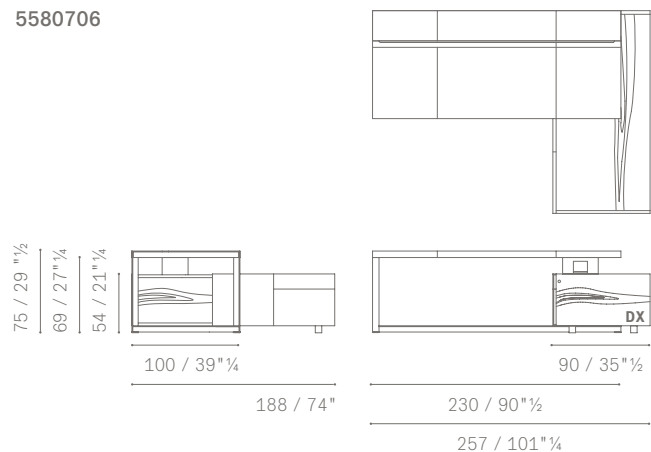

5580706

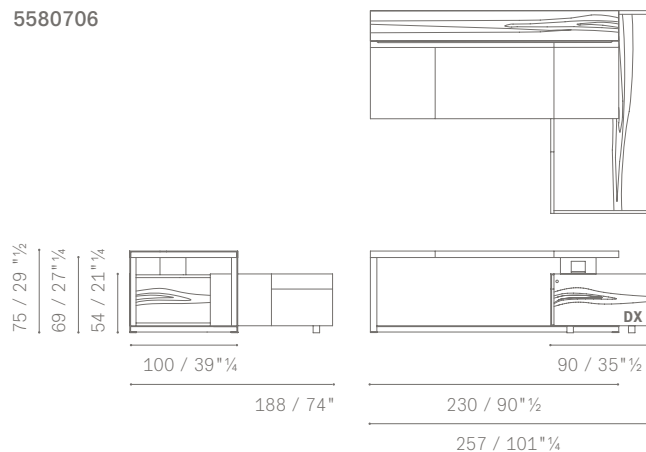

5580716

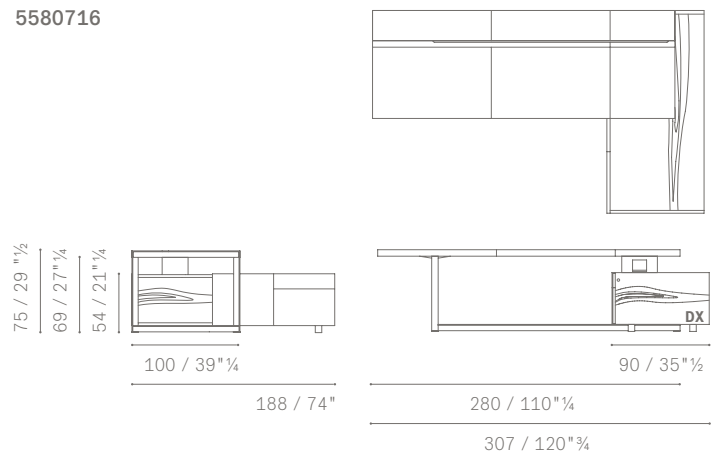

5580716

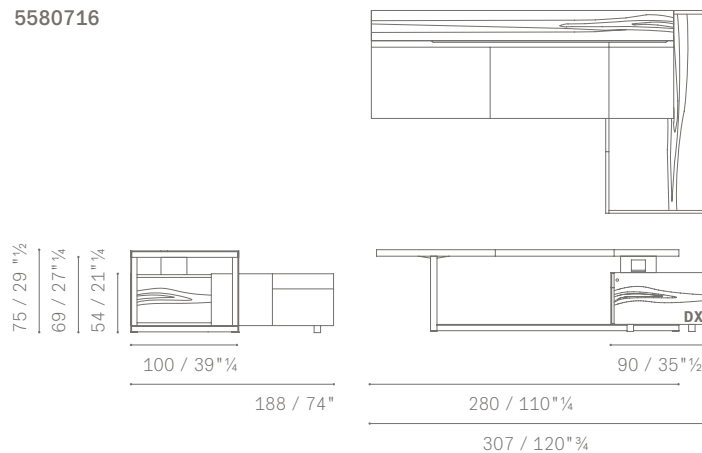

5580697

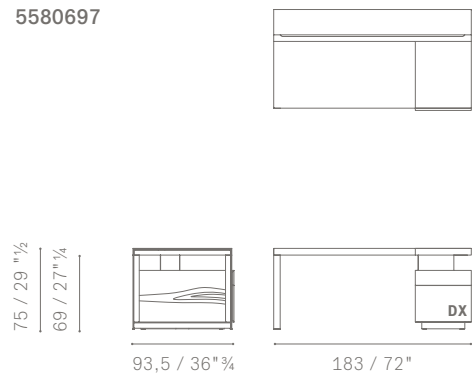

5580697

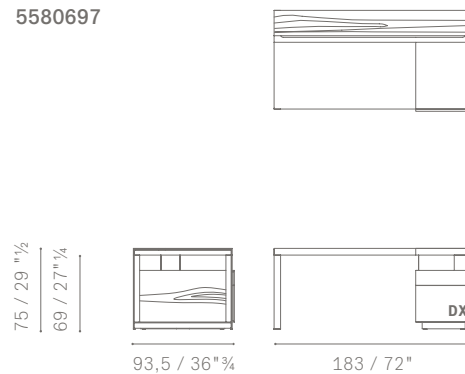

5580705

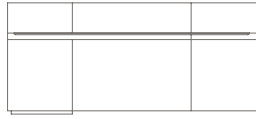

75 / 29" ½
69 / 27" ¼

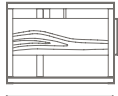

100 / 39" ¼
103 / 40" ½



230 / 90" ½

5580705



75 / 29" ½
69 / 27" ¼

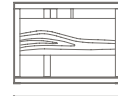

100 / 39" ¼
103 / 40" ½

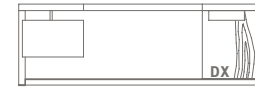

230 / 90" ½

5580725

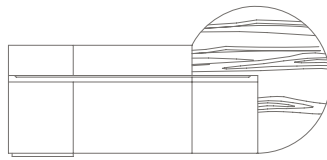

75 / 29" ½
69 / 27" ¼

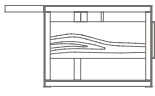

100 / 39" ¼
136 / 53" ½

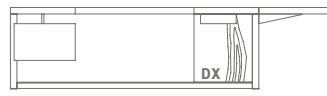

230 / 90" ½
298 / 117" ½

5580725

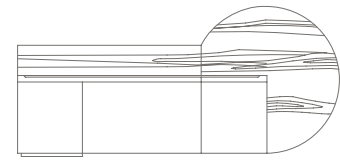

75 / 29" ½
69 / 27" ¼

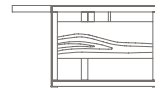

100 / 39" ¼
136 / 53" ½

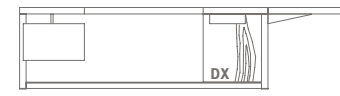

230 / 90" ½
298 / 117" ½

5580715



75 / 29" ½
69 / 27" ¼

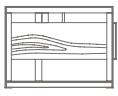

100 / 39" ¼
103 / 40" ½

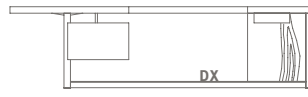

230 / 90" ½
280 / 110" ¼

5580715

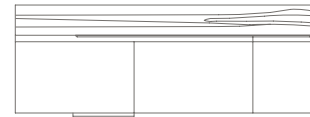

75 / 29" ½
69 / 27" ¼

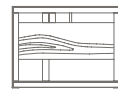

100 / 39" ¼
103 / 40" ½

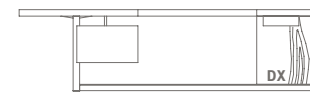

230 / 90" ½
280 / 110" ¼

5580701

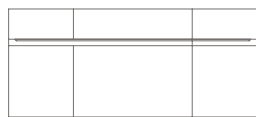

75 / 29" ½
69 / 27" ¼

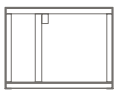

100 / 39" ¼



230 / 90" ½

5580701

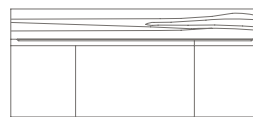

75 / 29" ½
69 / 27" ¼

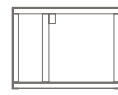

100 / 39" ¼



230 / 90" ½

5580721

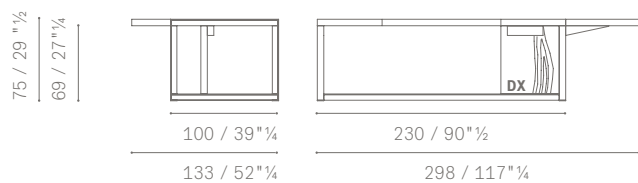
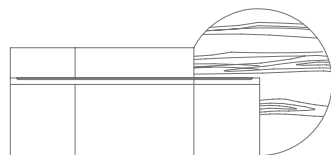

5580721

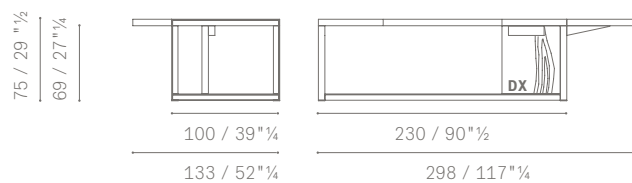
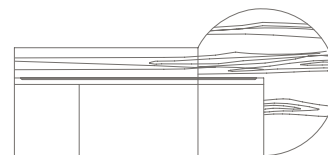

5580711

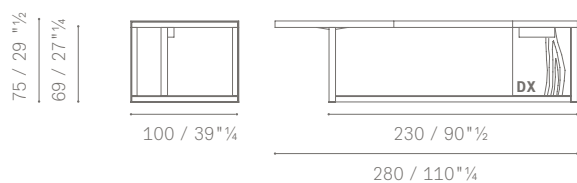
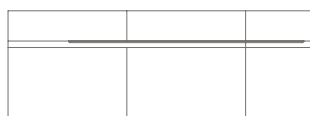

5580711

