

FLEXFORM

MADE IN ITALY



> OUTDOOR COLLECTION

ANY DAY OUTDOOR *CHRISTOPHE PILLET 2020*

TAVOLINI | CONSOLE COFFEE AND SIDE TABLES | CONSOLES

FLEXFORM Spa

Via Einaudi 23/25 20821 Meda (MB) Italy | Tel. +39 0362 3991 | Fax +39 0362 399228 | info@flexform.it | www.flexform.it

ANY DAY OUTDOOR | CHRISTOPHE PILLET | 2020

TIPOLOGIE POLTRONE/POUF - TAVOLINI/CONSOLLE **PRODOTTO** TAVOLINO - CONSOLLE **STRUTTURA** IN ACCIAIO INOX 316 NELLE FINITURE ELETTRILUCIDATO O VERNICIATO A FORNO CON POLVERI EPOSSIDICHE NEI COLORI BIANCO 100, ROSSO VINO 405, VERDE KAKI 705, BRUNITO **PIANO** IN LEGNO MASSELLO DI IROKO NELLE FINITURE NATURALE, TINTO GRIGIO, LACCATO BIANCO O IN PIETRA NELLE TIPOLOGIE PORFIDO, CARDOSO, LAVICA, BEOLA ARGENTATA **PIEDI** APPOGGIO A TERRA SU PUNTALI IN MATERIALE TERMOPLASTICO **COVER** IN MATERIALE IMPERMEABILE, LA COVER È A RICHIESTA CON SUPPLEMENTO DI PREZZO

CATEGORIES ARMCHAIRS/OTTOMANS - COFFEE TABLES/SIDE TABLES/ CONSOLES **PRODUCT** COFFEE TABLE - SIDE TABLE - CONSOLE **STRUCTURE** IN 316 STAINLESS STEEL WITH ELECTROPOLISHED OR BURNISHED FINISH; OR, EPOXY-POWDER-COAT FINISH IN WHITE 100, WINE RED 405 OR KHAKI GREEN 705 **TOP** IN SOLID IROKO WOOD WITH NATURAL, STAINED GREY OR LACQUERED WHITE FINISH; OR, IN THE FOLLOWING TYPES OF STONE: PORPHYRY, CARDOSO, LAVA, BEOLA ARGENTATA (SILVERY GREEN GNEISS) **FEET** REST ON TIPS MADE OF THERMOPLASTIC MATERIAL **COVER** IN WATERPROOF MATERIAL; COVER IS UPON REQUEST, WITH UPCHARGE

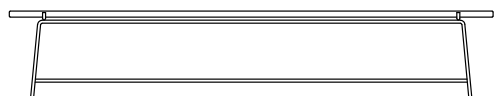



282H0

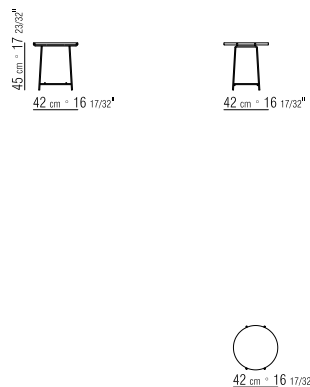

282H2

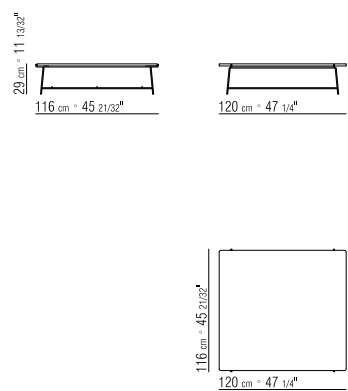

282H5

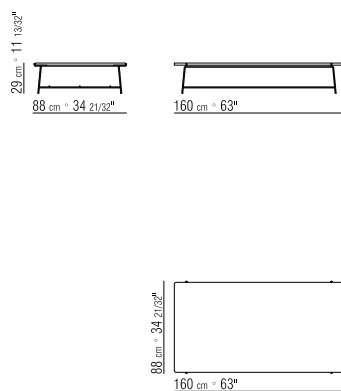

282H8

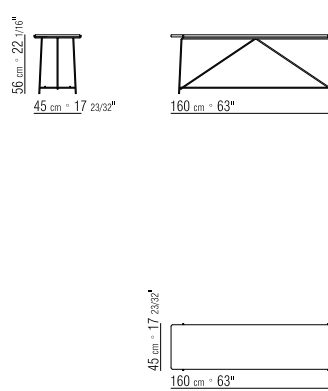

282K2

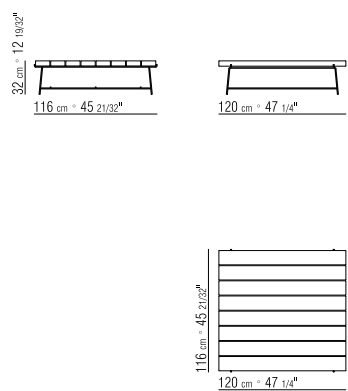

282K5

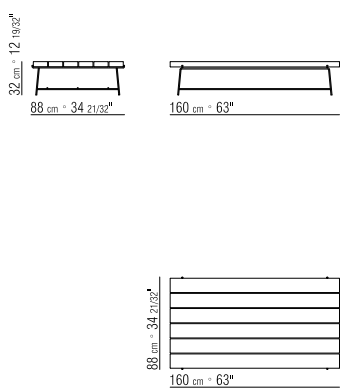

282K8

