

FLEXFORM

MADE IN ITALY



BRETTON *ANTONIO CITTERIO* 2021

DIVANI | DIVANI COMPONENTI | POUF SOFAS | SECTIONAL SOFAS | OTTOMANS

FLEXFORM Spa

Via Einaudi 23/25 20821 Meda (MB) Italy | Tel. +39 0362 3991 | Fax +39 0362 399228 | info@flexform.it | www.flexform.it

BRETTON | ANTONIO CITTERIO | 2021

Telaio seduta

in metallo rivestito in cuoio nei colori: bianco (5007), grigio (5003), testa di moro (5004), testa di moro scuro (5013), nero (5005), oliva (5006), rosso bulgaro (5008), sabbia (5001), tabacco (5015), scamosciato moro (6004), scamosciato nero (6005), scamosciato oliva (6003), scamosciato sabbia (6001). Con materassino in poliuretano espanso

Schienale

in metallo con imbottitura in poliuretano stampato rivestito in tessuto protettivo accoppiato

Bracciolo

in metallo rivestito in cuoio nei colori: bianco (5007), grigio (5003), testa di moro (5004), testa di moro scuro (5013), nero (5005), oliva (5006), rosso bulgaro (5008), sabbia (5001), tabacco (5015), scamosciato moro (6004), scamosciato nero (6005), scamosciato oliva (6003), scamosciato sabbia (6001)

Cuscini seduta

in fibra di poliestere con inserto in materiale indeformabile a densità unica. Seduta premium in piuma d'oca sterilizzata (certificata Assopiuma, Etichetta Oro) con inserto in materiale indeformabile ad alta resilienza

Cuscini schienale

in piuma d'oca sterilizzata (certificata Assopiuma, Etichetta Oro)

Cuscini optional

in piuma d'oca sterilizzata (certificata Assopiuma, Etichetta Oro), a richiesta con supplemento di prezzo

Piedi

in alluminio pressofuso nelle finiture colore grigio, bronzo 820, satinato, cromato, brunito, cromo nero, canna di fucile. Appoggio a terra su puntali in materiale termoplastico

Rivestimento

sfoderabile sia nella versione in tessuto che nella versione in pelle

Profilo rivestimento

la confezione prevede un profilo in gros grain che può essere realizzato in tutti i colori della cartella campioni

Seat frame

in metal clad in cowhide in the following colors: white (5007), grey (5003), dark brown (5004), extra dark brown (5013), black (5005), olive (5006), Bulgarian red (5008), sand (5001), tobacco (5015), dark brown suede (6004), black suede (6005), olive suede (6003), sand suede (6001).
With polyurethane foam mattress

Backrest

in metal with molded polyurethane padding, covered with a protective laminated fabric

Armrest

in metal clad in cowhide in the following colors: white (5007), grey (5003), dark brown (5004), extra dark brown (5013), black (5005), olive (5006), Bulgarian red (5008), sand (5001), tobacco (5015), dark brown suede (6004), black suede (6005), olive suede (6003), sand suede (6001)

Seat cushions

in polyester fiber with insert in single-density crushproof material.
Premium seat cushions in sterilized goose down (Assopiuma Certified, Gold Label) with insert in high resilience crushproof material

Backrest cushions

in sterilized goose down (Assopiuma Certified, Gold Label)

Optional cushions

in sterilized goose down (Assopiuma Certified, Gold Label); upon request, with upcharge

Feet

in cast aluminum with grey, bronze 820, satin, chrome, burnished, black chrome, or gun metal finish. Rests on tips made of thermoplastic material

Upholstery

is removable in both the fabric and leather versions

Upholstery piping

fine tailoring includes grosgrain piping that can be crafted in all the colors on the sample board

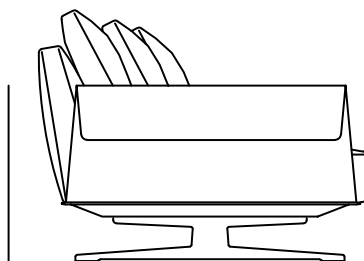

110 cm x 12 5/16"









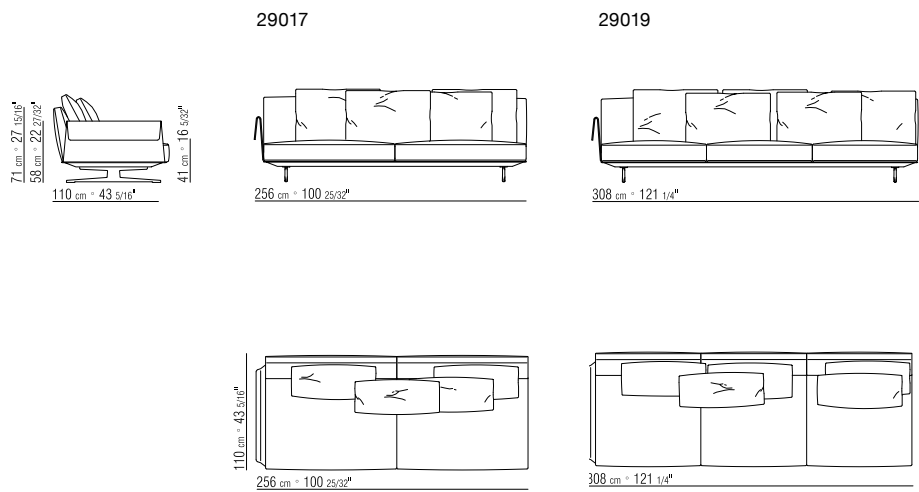
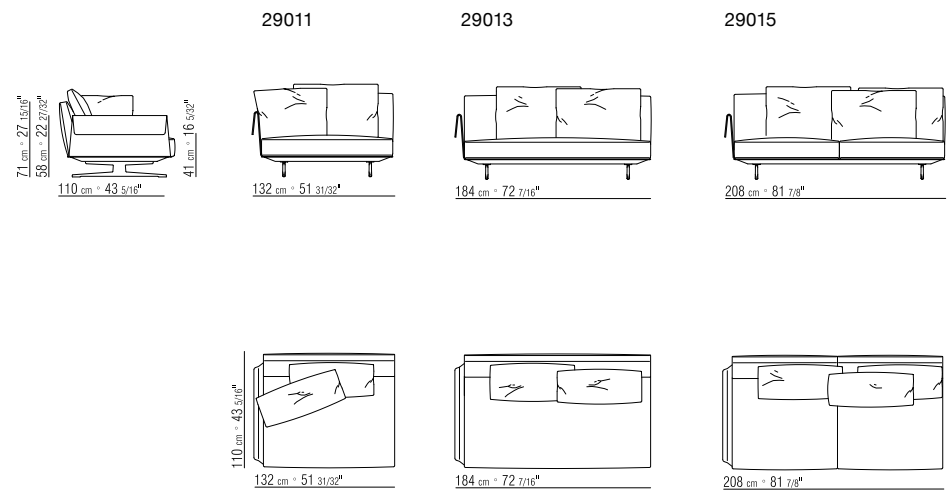
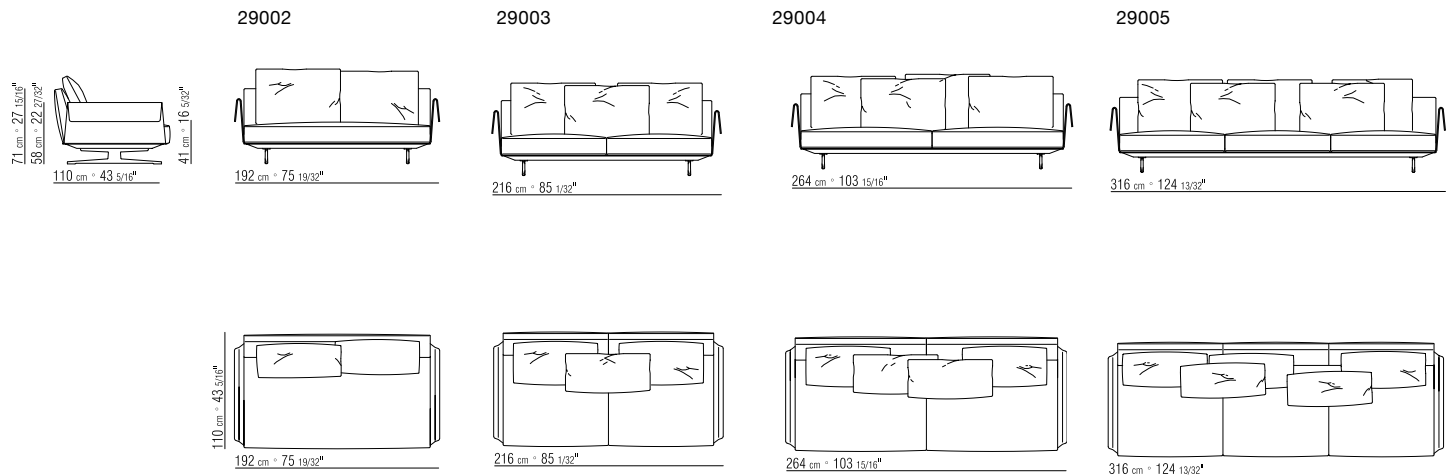

29021

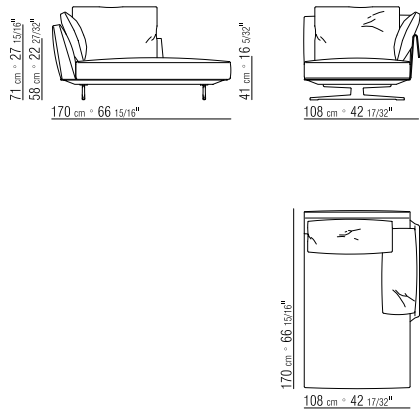

29027

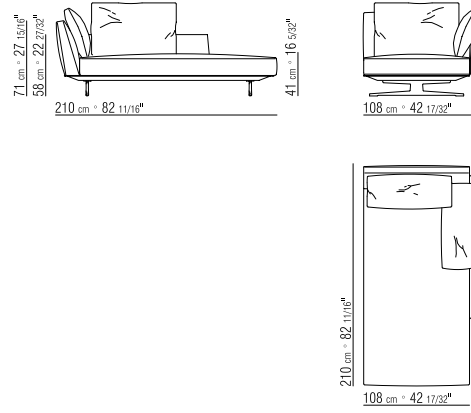

29031

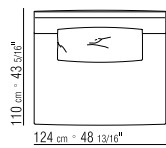
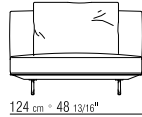
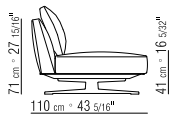

29032

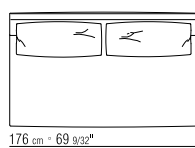
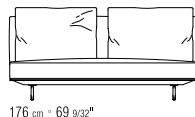

29033

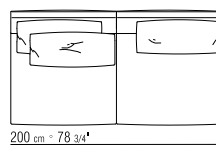
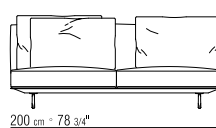

29034

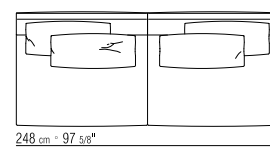
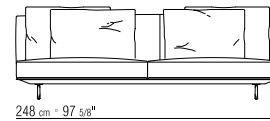

29098

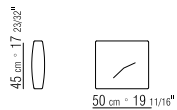

29099

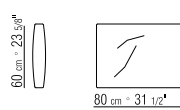

290XA

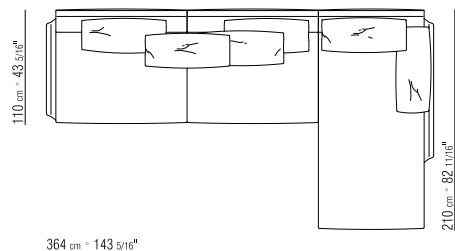

- | | | |
|---|--|--------------------------------------|
| N.1 COD. 29017 fianco sx cm.256x110 | | N.1 COD. 29017 end unit l cm.256x110 |
| N.1 COD. 29027 fianco terminale sx cm.210 | | N.1 COD. 29027 long corner l cm.210 |
| cuscini optional suggeriti (prezzo non incluso) suggested option cushion (price not included) | | |
| N.2 COD. 29098 cuscino cm.50x45 | | N.2 COD. 29098 cushion cm.50x45 |
| N.2 COD. 29099 cuscino cm.80x60 | | N.2 COD. 29099 cushion cm.80x60 |

290XB

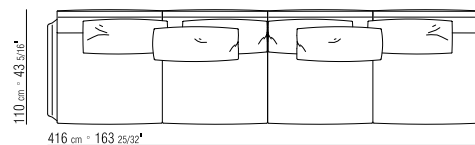

- | | | |
|---|--|--------------------------------------|
| N.1 COD. 29015 fianco sx cm.208x110 | | N.1 COD. 29015 end unit l cm.208x110 |
| N.1 COD. 29014 fianco dx cm.208x110 | | N.1 COD. 29014 end unit r cm.208x110 |
| cuscini optional suggeriti (prezzo non incluso) suggested option cushion (price not included) | | |
| N.2 COD. 29098 cuscino cm.50x45 | | N.2 COD. 29098 cushion cm.50x45 |
| N.2 COD. 29099 cuscino cm.80x60 | | N.2 COD. 29099 cushion cm.80x60 |